

温度保险丝

Thermal-Link (ATCO)

U系列 Series



应用 Applications

- 灯具 Lamps
- 开关电源 Switched-Mode Power Supplies
- 家用电器 Home Electrical Appliances
- 变压器 Transformers
- 电机 Motors
- 电容器 Capacitors
- 防雷插座 Power Strips

特性 Features

- 动作温度精确 High Accuracy of Functioning Temp.
- 一次性动作而不可复位 Non-Resettable
- 环保型产品 RoHS & REACH Compliant

定制 Customization

- 温度 Temp.
- 引线长度 The Length of Lead Wires
- 可编带包装 Taping Packing Available
- 引线可采用绝缘线 Lead Wires can be Insulated

ATCO

ATCO

安规认证 Agency Approvals



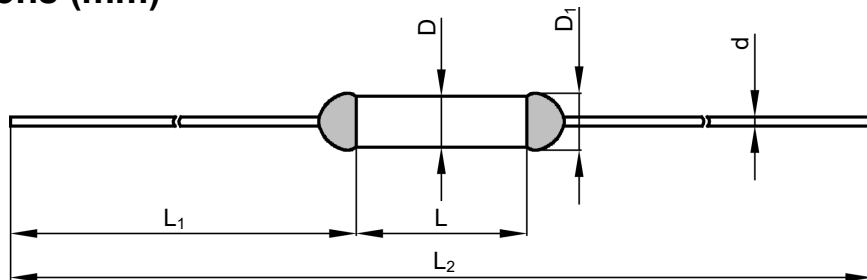

安规 Agency Mark	标准 Standards	认证号 No.
	UL 60691	E214712
	CAN-CSA-E60691	E214712
	EN 60691	R50207621
	GB 9816.1	2020980205000193

尺寸 Dimensions (mm)



L	L ₁	L ₂	D	D ₁	d
14.0 ± 0.5	33.0 ± 2.0	80.0 ± 3.0	4.0 ± 0.5	≤ 4.5	1.05 ± 0.05

技术参数 Specifications

型号 Model	额定动作 温度 T_f	熔断温度 Fusing Temp.	保持温度 T_h	极限温度 T_m	额定电流 I_r	额定电压 U_r	标称放电电流 I_n 8 / 20 μ s (15 Times)	最大放电电流 I_{max} 8 / 20 μ s (1 Time)					RoHS REACH
	(°C)	(°C)	(°C)	(°C)	(A)	(V)	(kA)	(kA)	UL	cUL	TUV	CCC	
U0	76	73 ± 2	43	200	10	AC 250	3	6	○	○	●	●	●
						DC 60	3	6	○	○	●	●	●
U18	86	81 ± 2	51	200	10	AC 250	3	6	○	○	●	●	●
						DC 60	3	6	○	○	●	●	●
U1	102	98 ± 2	72	200	1	AC 250	4	8	○	○	●	●	●
						DC 60	4	8	○	○	●	●	●
U2	115	111 ± 3	85	200	10	AC 250	4	8	●	●	●	●	●
						DC 60	4	8	○	○	●	●	●
U3	125	121 ± 2	95	200	10	AC 250	4	8	○	○	●	●	●
						DC 60	4	8	○	○	●	●	●
U4	130	125 ± 2	100	200	10	AC 250	4	8	○	○	●	●	●
						DC 60	4	8	○	○	●	●	●
U5	135	130 ± 2	105	200	10	AC 250	4	8	●	●	●	●	●
						DC 60	4	8	○	○	●	●	●
U6	145	140 ± 2	115	200	10	AC 250	4	8	○	○	●	●	●
						DC 60	4	8	○	○	●	●	●
U7	150	145 ± 2	120	200	10	AC 250	4	8	○	○	●	●	●
						DC 60	4	8	○	○	●	●	●
U16	160	155 ± 2	130	200	10	AC 250	4	8	○	○	●	●	●
						DC 60	4	8	○	○	●	●	●
U32	205	199 ± 3	167	250	10	AC 250	5	10	○	○	●	●	●
						DC 60	5	10	○	○	●	●	●
U31	221	218 ± 2	186	250	10	AC 250	5	10	●	●	●	●	●
						DC 60	5	10	○	○	●	●	●

备注 Note:

"●"表示产品已通过认证。Means certificated.

"○"表示产品未有认证。Means non-certificated.

ATCO

ATCO

产品温度时间曲线图 (仅供参考)
Product Temp.-Time Curve (For Reference Only)

温度保险丝在不同温度油浴中断开的温度时间曲线。
The Temp.-Time Curve of Thermal-Link in different Temp. oil baths.

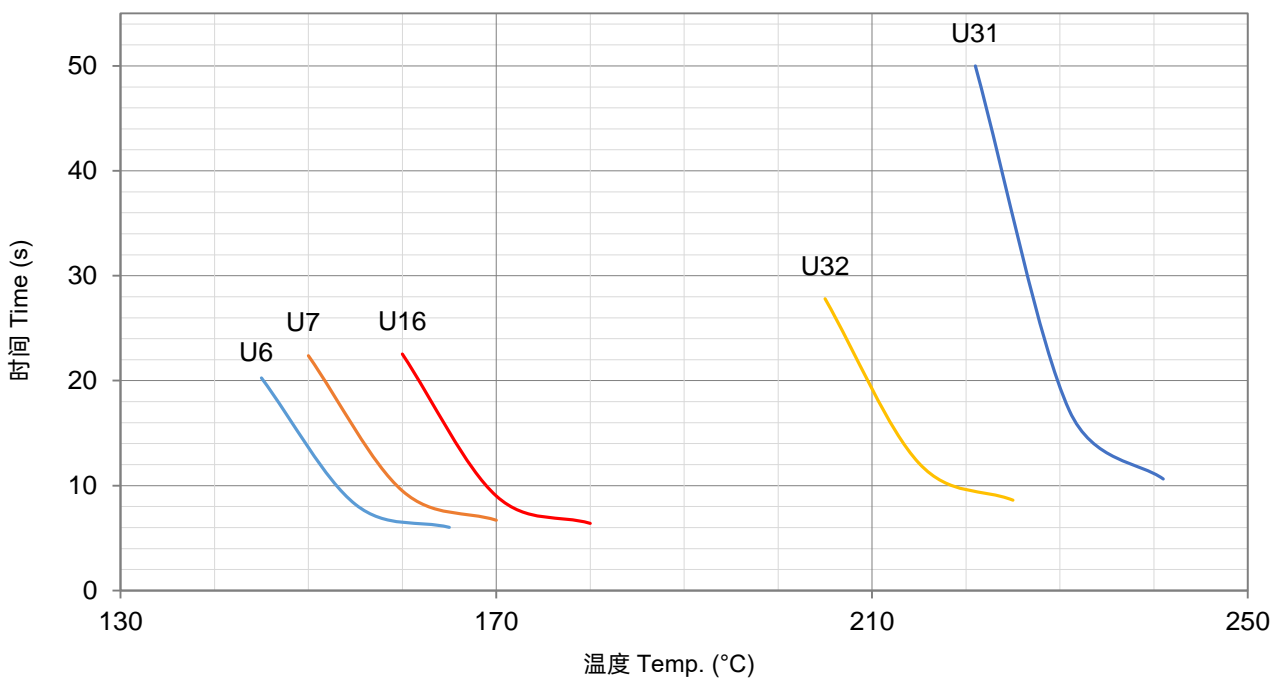
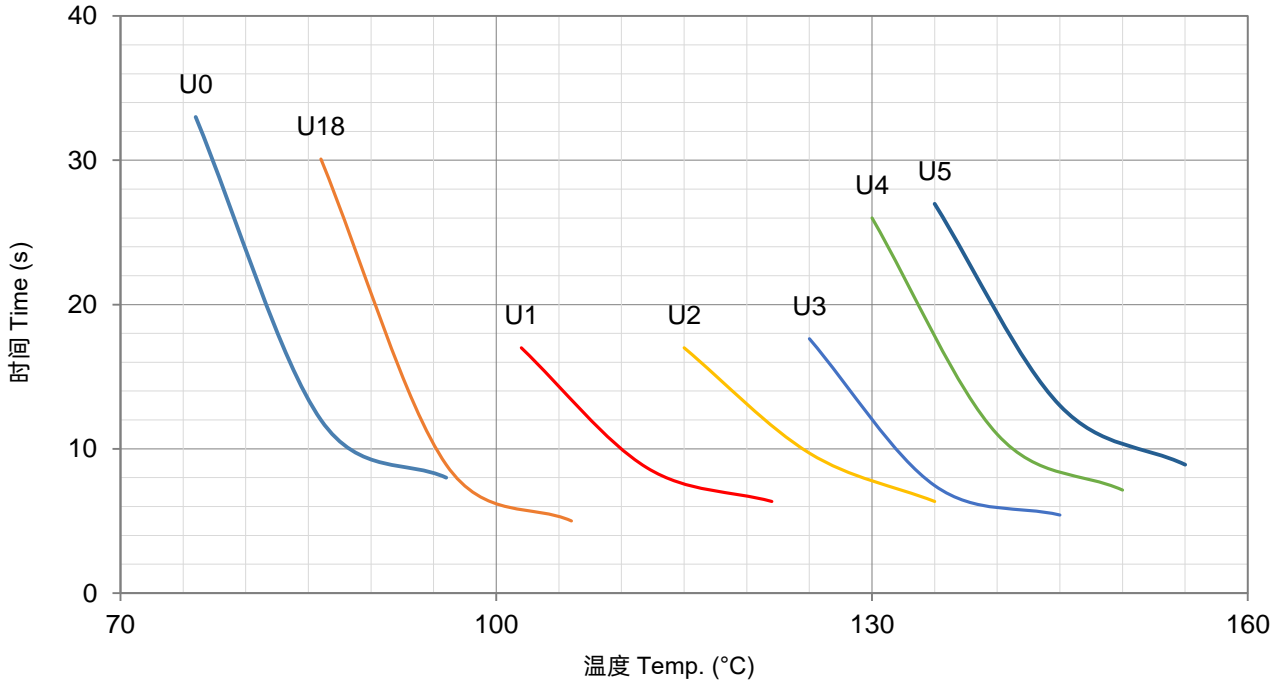

ATCO

ATCO

产品电流时间曲线图 (仅供参考)
Product Current-Time Curve (For Reference Only)

温度保险丝在室温 $25 \pm 2 \text{ }^\circ\text{C}$ 条件下, 测试数倍过载电流下的断开时间曲线。
The Current-Time Curve shows functioning time at multi-times rated current at room temperature $25 \pm 2 \text{ }^\circ\text{C}$.

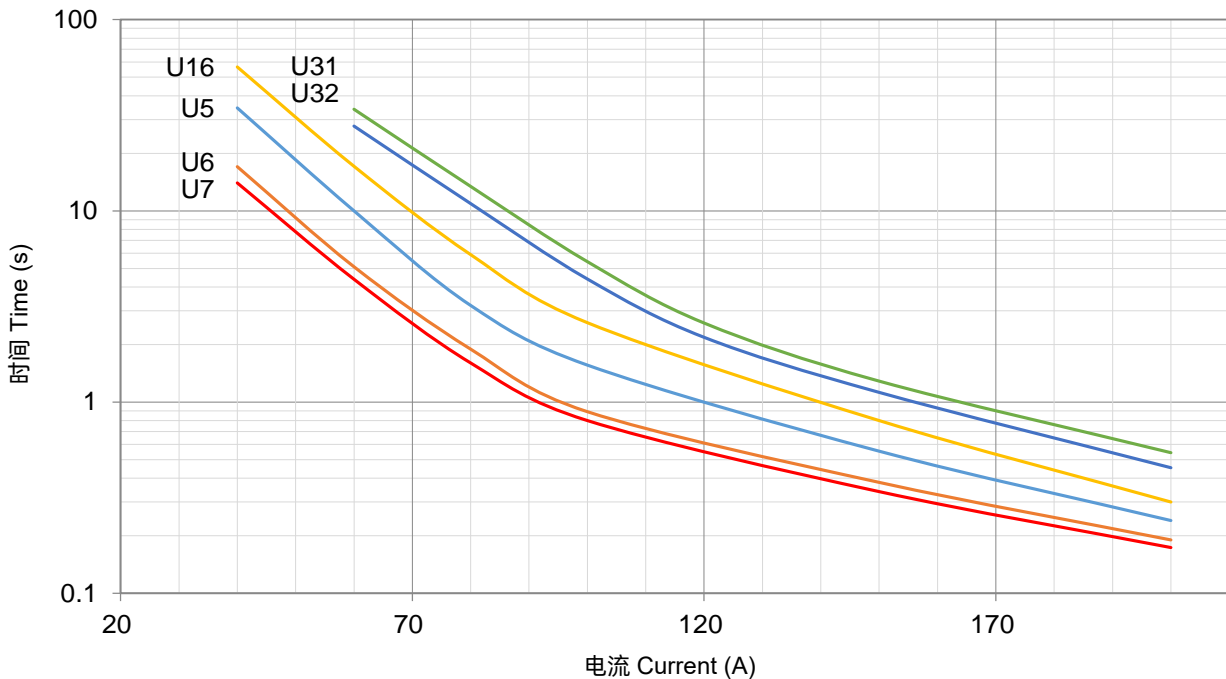
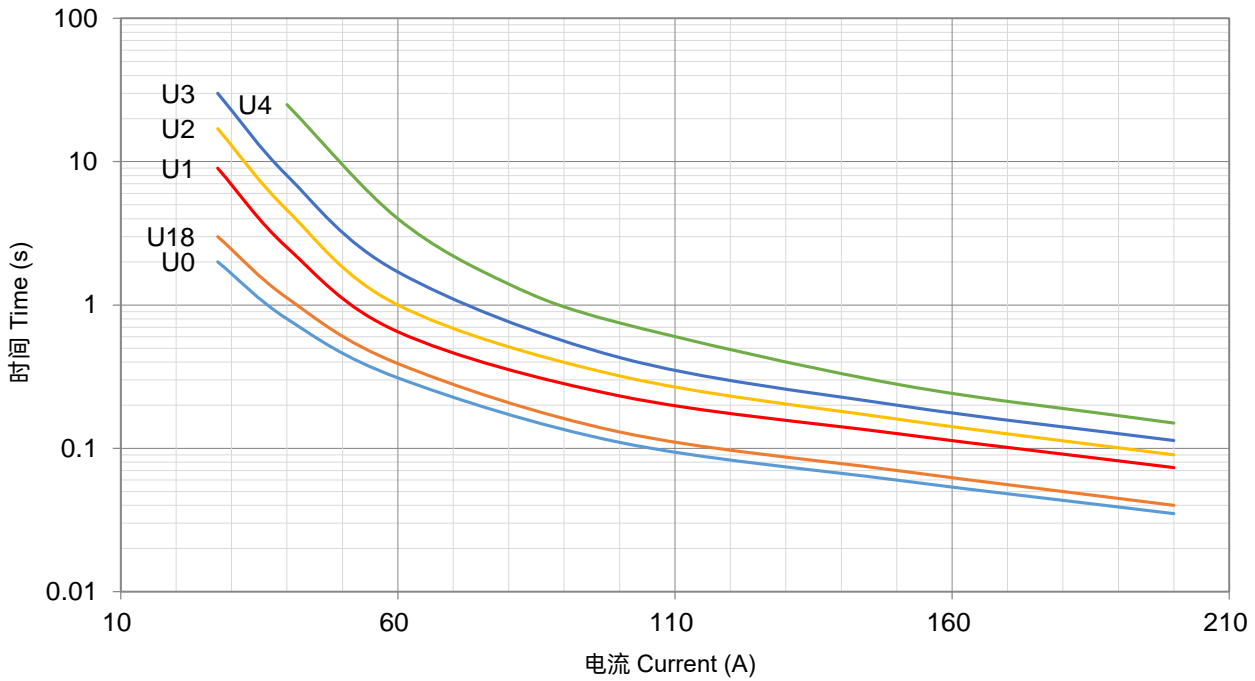

包装信息 Packaging Information

散装 Bulk

项目 Item	PE 袋 Bag	PE 袋 Bag	包装箱 Carton
尺寸 Dimensions (mm)	135 × 85	190 × 180	440 × 300 × 260
数量 Quantity (PCS)	50	300	12000
毛重 Gross Weight (kg)			16.0 ± 10%

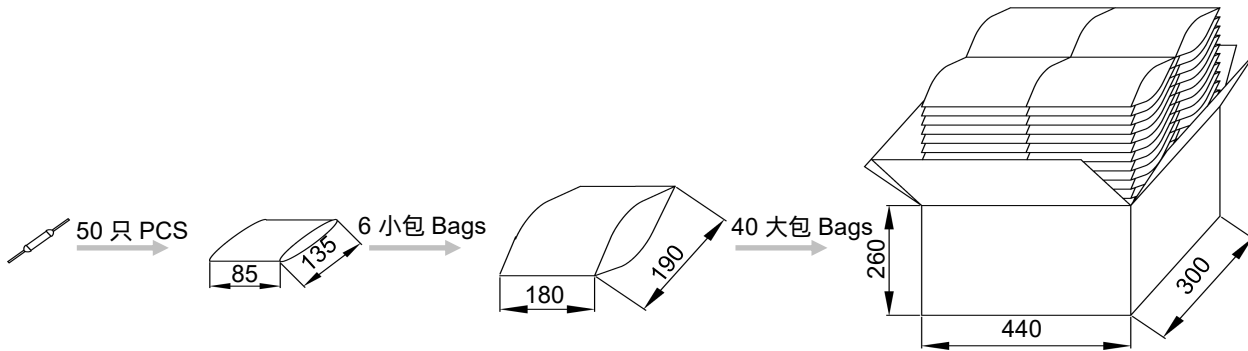

编带 Taping

项目 Item	卷轴 Scroll	盒子 Box	包装箱 Carton
尺寸 Dimensions (mm)	Φ 250 × 94	258 × 258 × 98	480 × 300 × 260
数量 Quantity (PCS)	2000	2000	8000
毛重 Gross Weight (kg)			10.5 ± 10%

